









LIME DIAMANTATE

GRANA D91 - D126

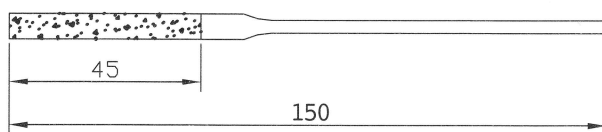
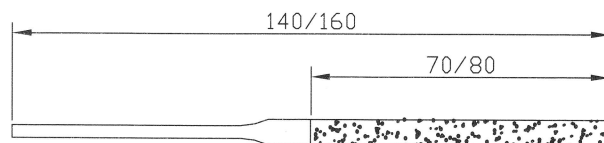
Lima diamantata		Sezione lima 140 x 70	Sezione lima 160 x 80
rettangolare		5.5 x 1.5	6 x 1.5
quadrata		3 x 3	6 x 2
triangolare		4 x 4	4.5 x 4.5
rotonda		Ø3.5	Ø3.5
mezza tonda		5 x 2	6.5 x 2







Lima mini

Lima diamantata tipo mini		Sezione lima 150 x 45
rettangolare		4 x 1.4
quadrata		2 x 2
triangolare		2.5 x 2.5
rotonda		Ø2
mezza tonda		4 x 1.5

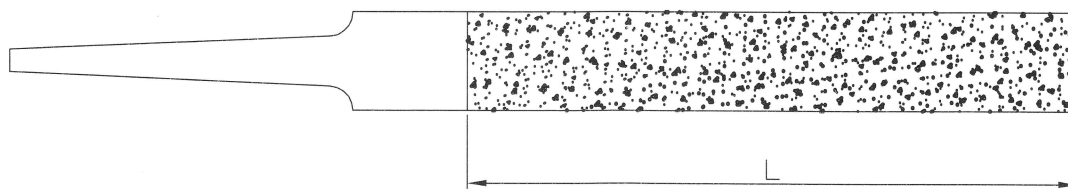
LIME SPECIALI

GRANA D126



Lima diamantata		Sezione Lima	L
rettangolare		10 x 3	75
rettangolare		10 x 3	100
rettangolare		12 x 2	70
rettangolare		15 x 3	125
triangolare		6 x 6	70

SI ESEGUONO FORME E DIAMETRI DIVERSI DALLO STANDARD

MOLETTE PER RETTIFICHE INTERNE

GRANA D107 - D126

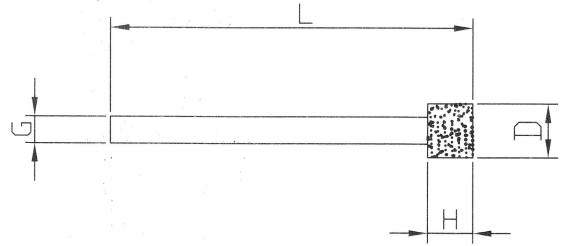
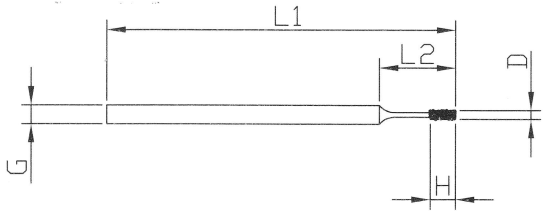

Codice	D	L1	L2	H	G
MR 0.8	0.8	55	10	3	3
MR 1	1	55	12	4	3
MR 1.25	1.25	55	12	4	3
MR 1.5	1.5	55	14	4	3
MR 1.75	1.75	55	14	4	3
MR 2	2	55	14	4	3
MR 2.5	2.5	55	20	4	3
MR 3	3	55	20	5	3
MR 3.5	3.5	55		5	3
MR 4	4	55		5	3
MR 4.5	4.5	55		5	3
MR 5	5	55		5	3

Codice	D	L1	L2	H	G
MR 3 S	3	80	35	8	6
MR 4 S	4	80	35	8	6
MR 5 S	5	80	35	8	6
MR 6.3	6.3	80		8	6
MR 7	7	80		10	6
MR 8	8	80		10	6
MR 9	9	80		10	6
MR 10	10	80		10	6
MR 12	12	80		10	6

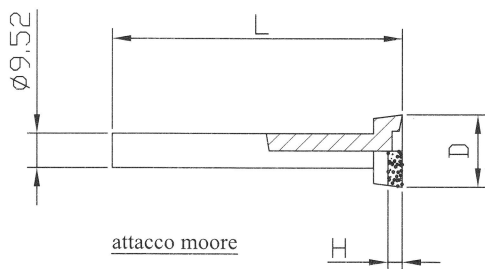

Codice	D	H	L
RIF 10	10	2	80
RIF 12	12	2	80
RIF 15	15	3	80
RIF 18	18	3	80
RIF 24	24	3	80

Codice	D	F
MR 12	12	6
MR 14	14	6
MR 15	15	6
MR 16	16	6
MR 18	18	8
MR 20	20	8

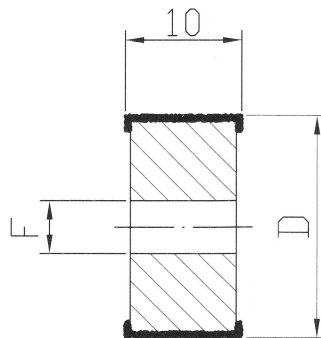

Codice	D	F
MR 22	22	8
MR 25	25	8
MR 30	30	8
MR 40	40	10
MR 50	50	10

SI ESEGUONO FORME E DIAMETRI DIVERSI DALLO STANDARD

MOLA A TAZZA E DISCO TRONCATORE

GRANA D76 - D151

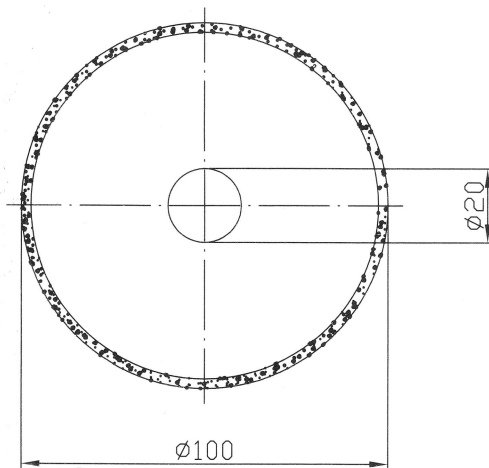
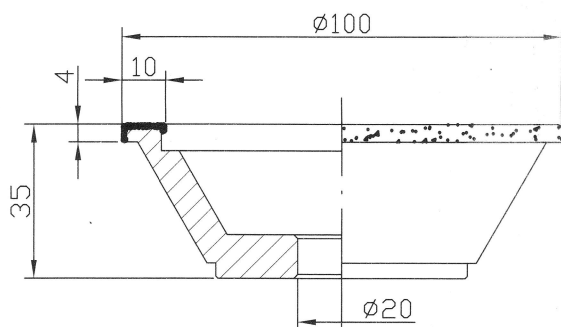

PASTA DIAMANTATA

lappatura	0.25 micron	(colore neutro)
finitura	1 micron	(colore avorio)
finitura	3 micron	(colore giallo)
prefinitura	6 micron	(colore arancio)
prefinitura	9 micron	(colore verde)
media sgrossatura	15 micron	(colore blu)
media sgrossatura	30 micron	(colore rosso)
forte sgrossatura	45 micron	(colore marrone)
forte sgrossatura	60 micron	(colore viola)

MOLE PERIFERICHE PIANE

GRANA D107 - D151

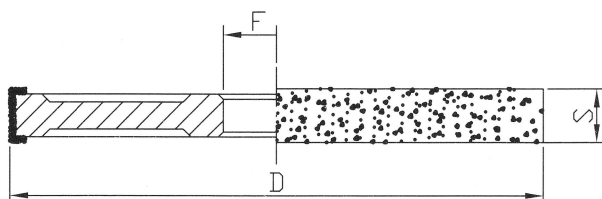

Codice	D	F	S
MP 100	100	20	10
MP 125	125	20	10
MP 150	150	-	10
MP 200	200	-	12
MP 250	250	-	12
MP 300	300	-	14

Foro F a richiesta

MOLE DIAMANTATE

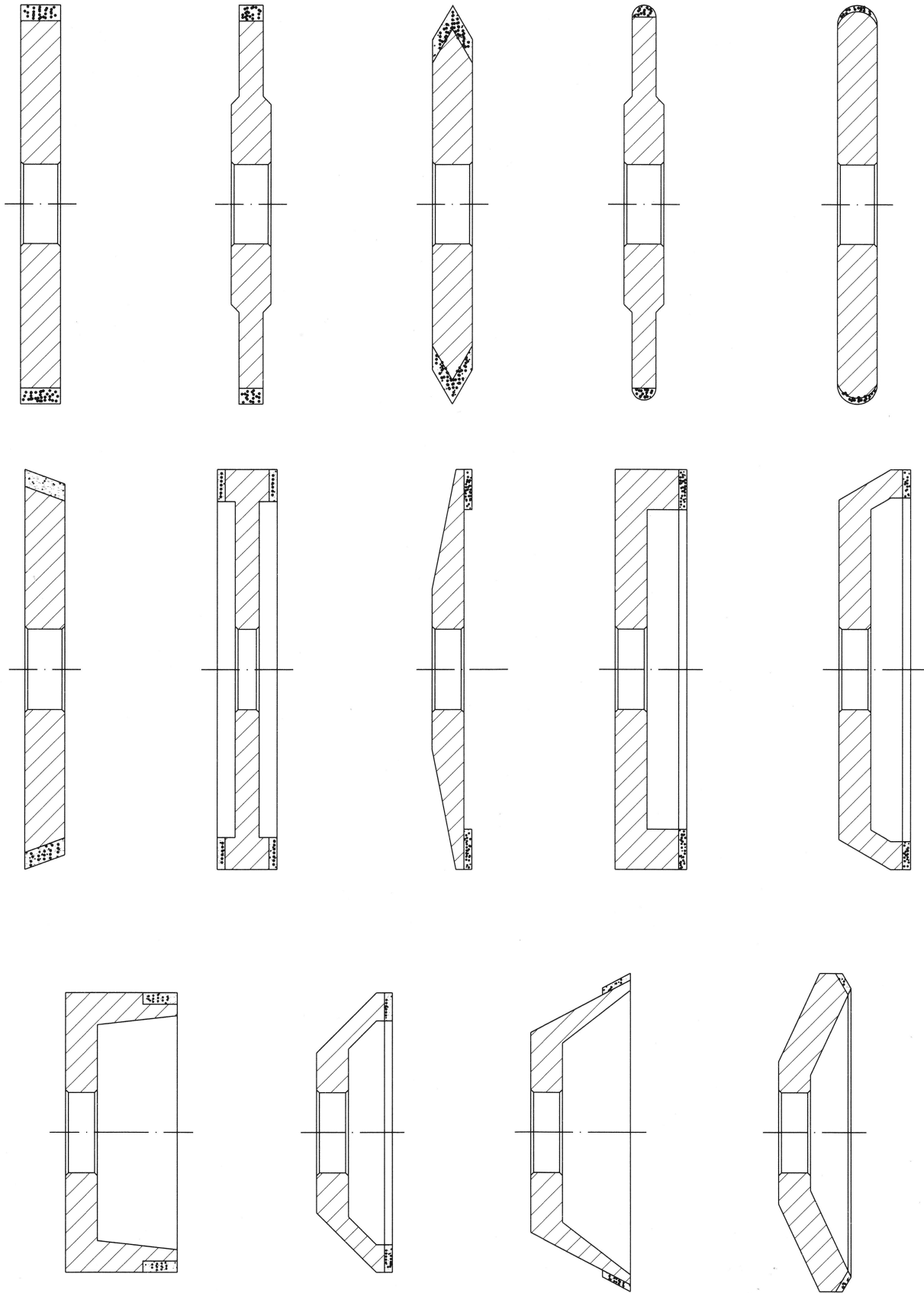

SI ESEGUONO FORME E DIAMETRI DIVERSI DALLO STANDARD